

# A-dec Inspire® Dental Furniture



Content Map .....	1
Operate/Adjust .....	2
Clean/Maintain .....	26
Specifications .....	31

## Copyright

© 2024 A-dec, Inc. All rights reserved.

A-dec, Inc. makes no warranty of any kind with regard to this material, including, but not limited to, the implied warranties of merchantability and fitness for a particular purpose. A-dec, Inc. shall not be held liable for any errors contained herein or any consequential or other damages concerning the furnishing, performance or use of this material. The information in this document is subject to change without notice. If you find any problems in the documentation, please report them to us in writing. A-dec, Inc. does not warrant that this document is error-free.

No part of this document may be copied, reproduced, altered, or transmitted in any form or by any means, electronic or mechanical, including photocopying, recording, or by any information storage and retrieval system, without prior written permission from A-dec, Inc.

## Intellectual Property Rights

None of the trademarks, trade names, or proprietary symbols and icons in this document may be reproduced, copied, or manipulated in any manner without the express, written approval of the trademark owner.

A-dec, A-dec+, the A-dec design logo, and the trademarks listed at [a-dec.com/legal/trademarks](http://a-dec.com/legal/trademarks) are A-dec trademarks or registered trademarks in the United States and other countries. Certain touch control symbols and icons are proprietary to A-dec, Inc.

In the United States, Pozidriv is a registered trademark of Phillips Screw Company, Purell is a registered trademark of GOJO Industries Inc., Bon Ami is a registered trademark of Bon Ami Company, Comet is a registered trademark of KIK International LLC, Fantastic is a registered trademark of S.C. Johnson & Son, Inc., Formula 409 and SOS are registered trademarks of The Clorox Company, Scotch-Brite is a registered trademark of 3M Company, and Soft Scrub is a registered trademark of Henkel Consumer Goods Inc. These may also be trademarks or registered trademarks in other countries.

## Regulatory Information and Warranty

For required regulatory information and the A-dec warranty, see the *Regulatory Information, Specifications, and Warranty* document (p/n 86.0221.00) available in the Resource Center at [www.a-dec.com](http://www.a-dec.com).



For quick access to this document online, scan, tap, or click this QR code, which points to: [a-dec.com/regulatory-guide](http://a-dec.com/regulatory-guide).

## Product Service

Product service is available through your local authorized A-dec dealer. For service information, or to locate an authorized dealer, contact A-dec at 1.800.547.1883 in the USA and Canada or +1.503.538.7478 worldwide, or visit [www.a-dec.com](http://www.a-dec.com).

## Product Models and Versions Covered in This Document\*

Models	Versions	Description
391/393/395 396/591/592 593/595	A	Dental Furniture

\* Equipment shown in this document may include optional features or accessories. Some products, versions, and options in this document may not be available in certain regions.

## Video Support Icon



Topics noted with this icon are supported with supplemental video. Click on the icon to open the video directly in YouTube. For additional user support materials, go to [www.a-dec.com/InspireSupport](http://www.a-dec.com/InspireSupport).

# Content Map



*Note.* Click on any number to go to that topic. Model 591 shown.

## Topics

<b>1</b>	Control Center/Clock Timer.....	2, 11
<b>2</b>	Monitor Mount.....	12
<b>3</b>	Drawer Adjustments .....	14
<b>4</b>	Door Hinge Adjustments .....	20
<b>5</b>	Upper Dispensing .....	21
<b>6</b>	Soap/Hand Sanitizer Dispenser Refill .....	22
<b>7</b>	Auxiliary Devices .....	8, 24
<b>8</b>	A-dec ICV® Vacuum-Line Cleaner.....	9, 25
<b>9</b>	Foot-Activated Faucet .....	23
<b>10</b>	Delivery/Support System <i>See the Instructions for Use that came with your delivery or support system.</i>	

## Main Sections

Operate/Adjust .....	2
Clean/Maintain .....	26
Specifications .....	31

# Operate/Adjust

## Control Center Functions *(591 only)*

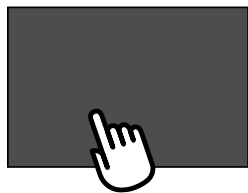
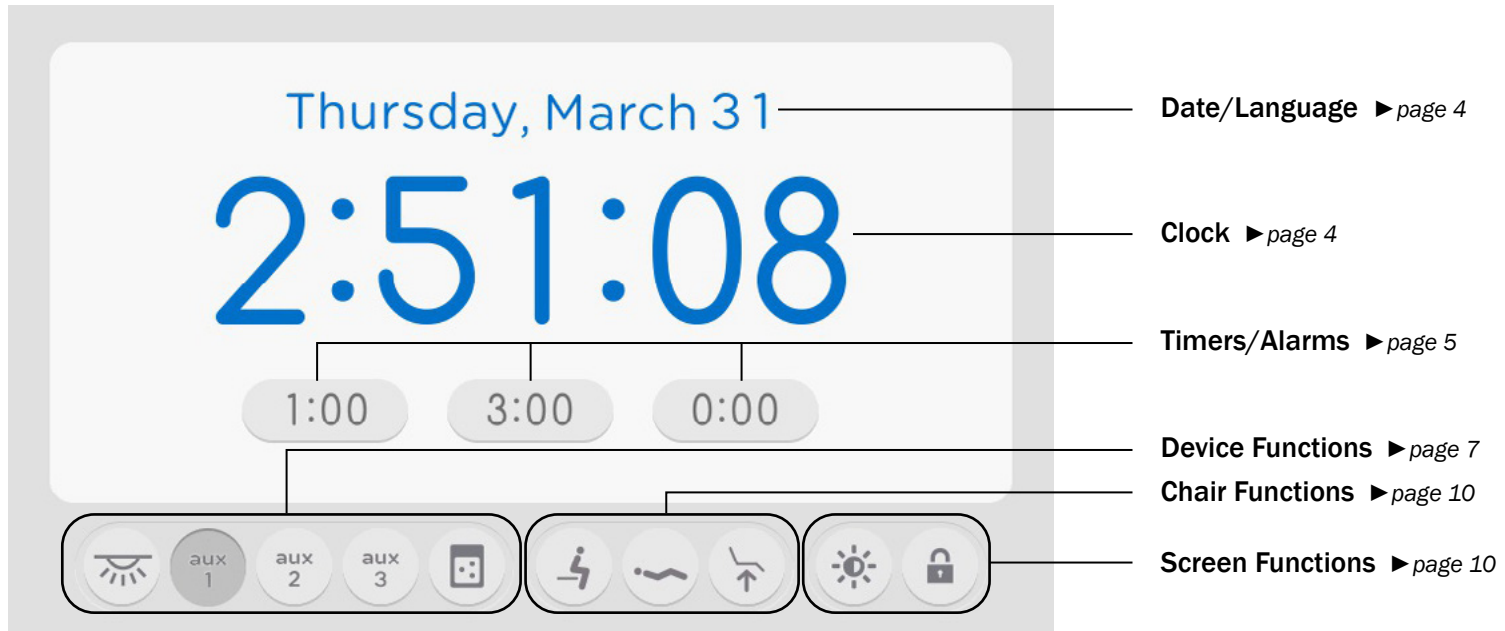

**Press** anywhere to turn the screen on.



**Press** the icon to activate.



**Press and hold** the icon to change settings.

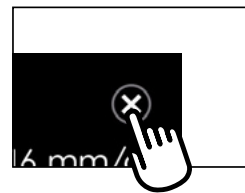

**Press X** to save settings.

### Touchscreen Operation

The touchscreen uses resistive technology, which requires a slight amount of pressure to operate. **Press** lightly on the touchscreen to make selections. **Press and hold** to change settings.

The screen automatically shuts off at midnight every day to extend the life of the screen. Simply tap on the screen to turn it back on.

*Note. Touch control icons and symbols are proprietary to A-dec, Inc.*

## How to Change Settings

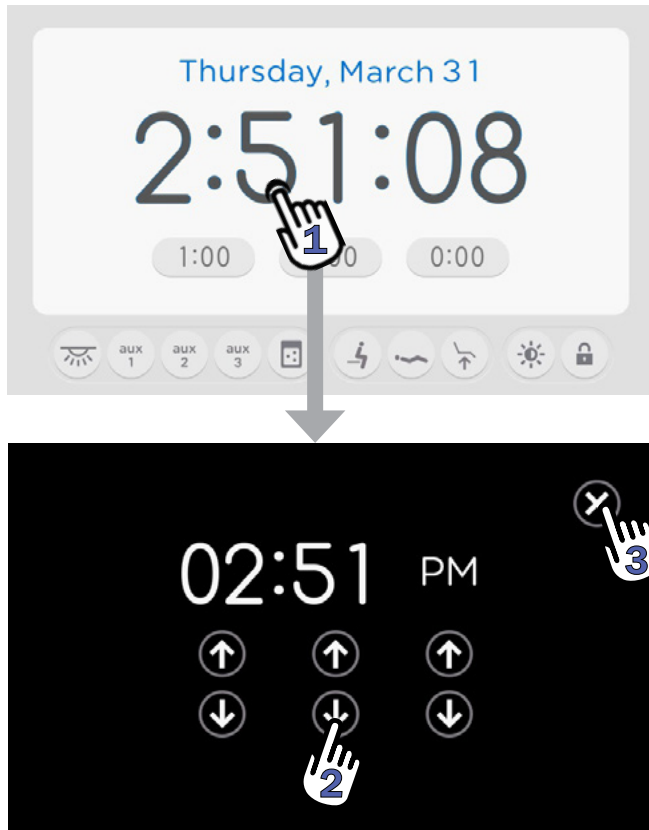

Clock Settings Window



**IMPORTANT** For a quick reminder of basic touchscreen features, see the *A-dec Inspire Control Center Quick Reference* (p/n 86.0631.00), which is included with your 591 Treatment Console and laminated so you can refer to it when necessary.

Function	Steps
Settings	<ol style="list-style-type: none"> <li>1. <b>Press and hold</b> the item on the touchscreen you want to change until the setting menu appears.</li> <li>2. <b>Press</b> the arrow(s) to change the current settings.</li> <li>3. <b>Press</b> <b>X</b> to save your settings and exit the menu.</li> </ol>



**NOTE** The settings window will close automatically after one minute if the screen has not been touched.

Some features, such as the task light and chair icons, do not offer settings.

### How to Set the Date and Language

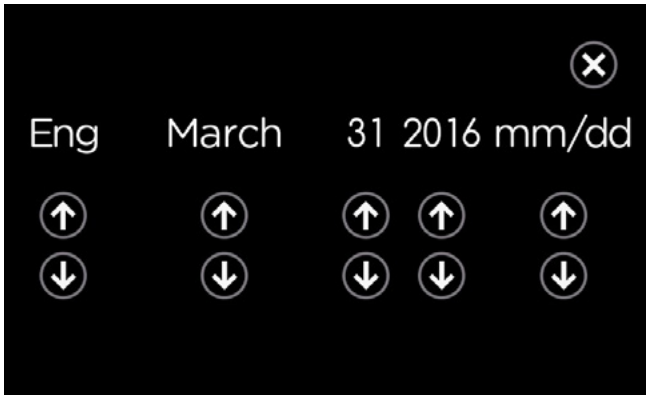

Date/Language Settings Window

Function	Steps
Language, Date, and Date Format	<ol style="list-style-type: none"> <li>1. Select English or French.</li> <li>2. Select the month, day, and year. The day of the week and leap year are determined automatically.</li> <li>3. Select your preferred date format (day/month, month/day).</li> </ol>



**NOTE** If your cabinet or office loses power for more than a week, you will need to reset the time and date. All other settings will remain in memory.

### How to Set the Clock

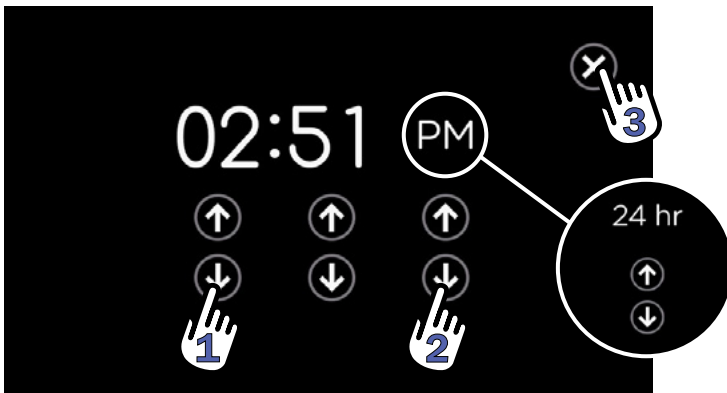

Clock Settings Window

Function	Steps
Clock	<ol style="list-style-type: none"> <li>1. Select the hours and minutes.</li> <li>2. Select AM, PM, or 24-hr setting.</li> <li>3. <b>Press X</b> to save your settings and exit the menu.</li> </ol>



**NOTE** Adjustments for Daylight Saving Time must be set manually.



## How to Set the Timer and Alarm

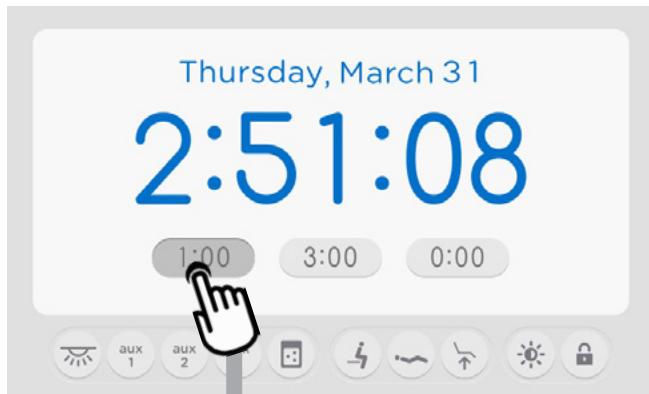

Main Window

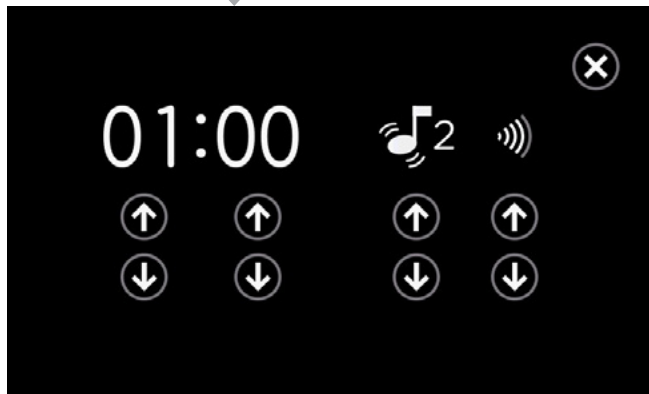

Timer/Alarm Settings Window

Function	Options/Actions
Timer Settings	<b>Press and hold</b> the timer icon to display the timer/alarm settings window.
Time Interval	Timers can be set to a maximum of 99:59 (minutes and seconds).
Timer Mode	Any of the three timers can be set to countdown or stopwatch mode. For the stopwatch mode, set the timer to 00:00 and press <b>X</b> to save and exit. The default display includes two countdown timers and one stopwatch timer.
Alarm Tone	After you change the alarm tone in the settings window, the control center will immediately play a sample of the tone.
Alarm Volume	After you change the alarm volume in the settings window, the control center will immediately play the selected tone at the selected volume.
 <b>NOTE</b>	Timer settings cannot be accessed or changed for the timer that is running.

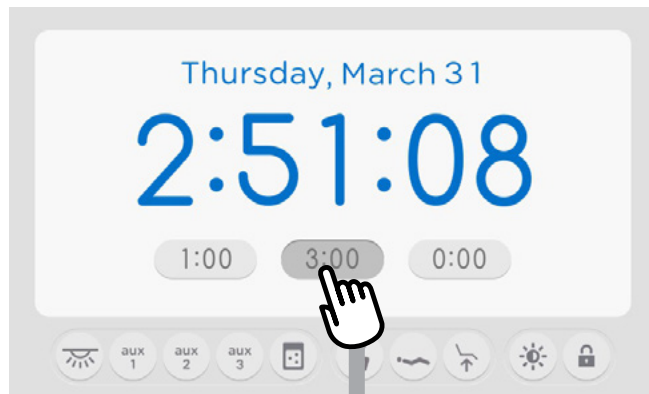

## How to Run and Reset Timers

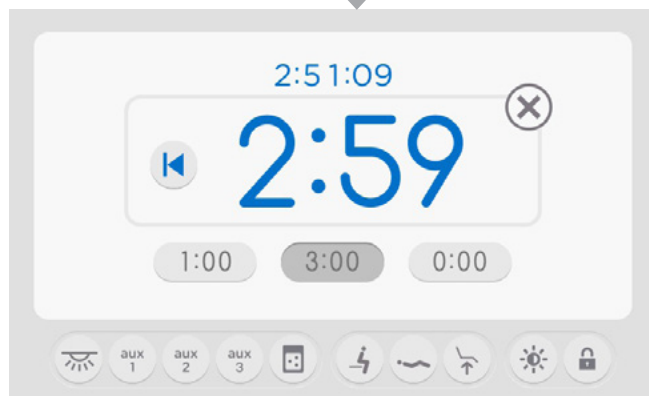

Main Window



Timer Window

Function	Steps
Run Timer	<b>Press</b> the timer icon to display and start the timer.
Reset Timer	<b>Press</b>  to reset the start time, or press the timer icon again.
Stop Timer	<b>Press</b>  to stop the timer. You can also press another timer icon to stop the current running timer and, alternatively, start the other timer.
<p> <b>NOTE</b> Timer settings cannot be accessed or changed for the timer that is running.</p>	



## How to Activate the Task Light

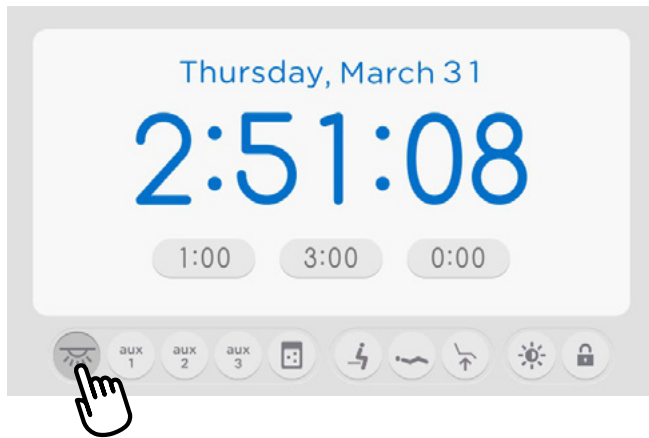
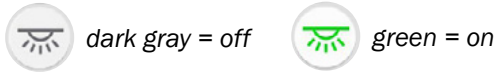

Function	Steps/Actions
Task Light	<b>Press</b> the task light icon to turn the A-dec Inspire task lights on or off. The icon detail is dark gray when the lights are off and turns green when the lights are on.
<p><b>NOTE</b> There are no task light settings on the control center. For manual-switch-controlled task lights, see “Operate the Task Light Switch” on page 12.</p>	

## How to Run and Set Auxiliary Devices

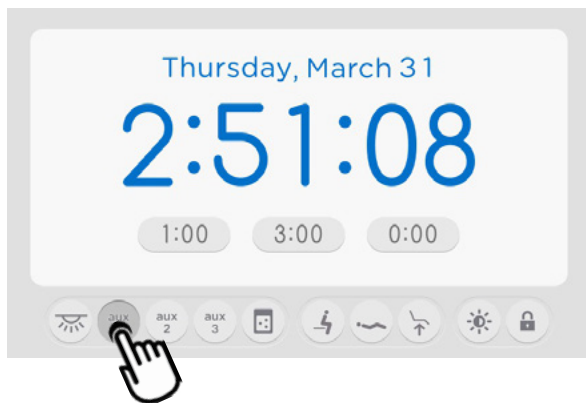
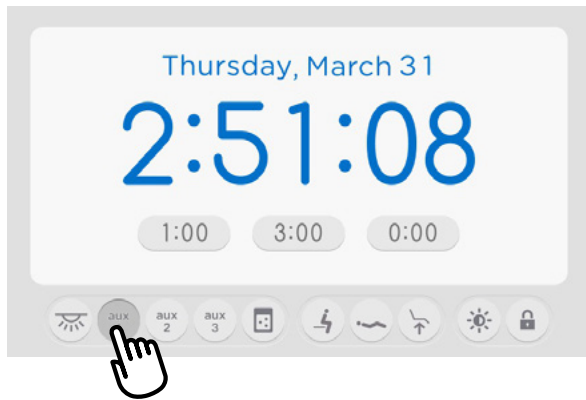
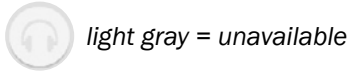
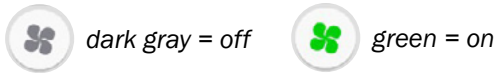
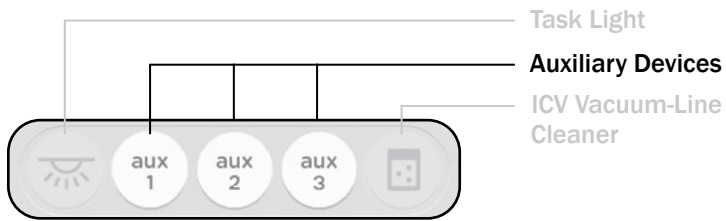

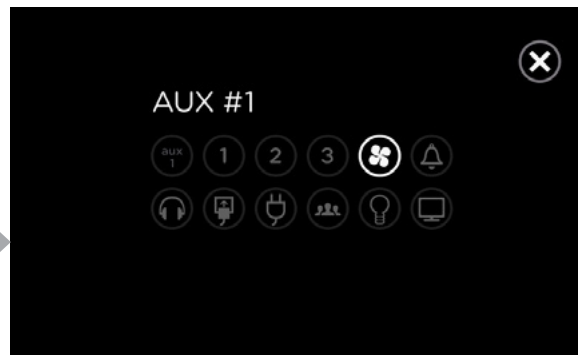

Function	Steps
<b>Auxiliary Device On/Off</b>	<b>Press</b> an auxiliary icon to turn the device on or off. The icon is dark gray when the device is off and green when the device is on.
<b>Auxiliary Device Icon</b>	<b>Press and hold</b> an auxiliary icon to select a different icon for your device. If the device icon is light gray, then the device is disconnected or not available.

**NOTE** Your auxiliary device setup depends on your cabinet configuration and what you requested during installation. You can easily add or remove devices as needed. For more information, see “Add Auxiliary Devices” on page 24.

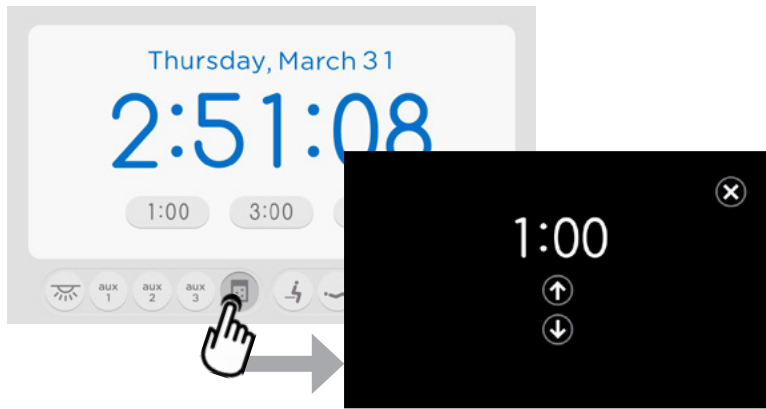
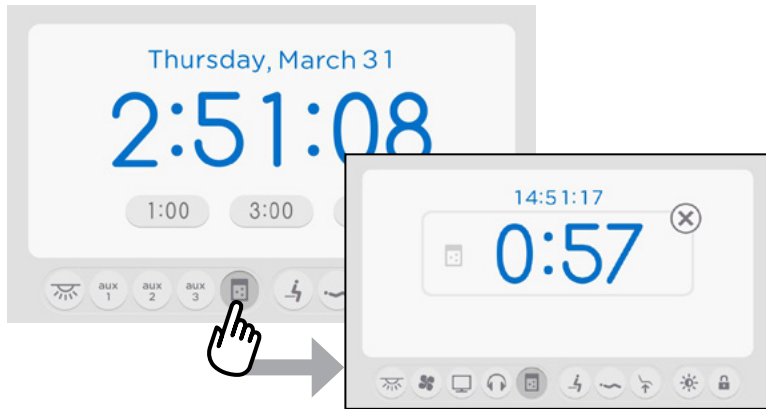
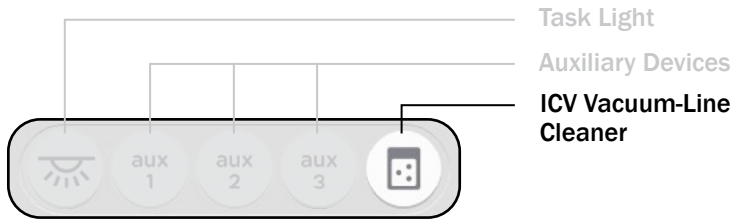

## How to Run and Set the A-dec ICV Vacuum-Line Cleaner



Function	Steps
Run ICV Vacuum-Line Cleaner	<b>Press</b> on the ICV icon to activate ICV and ICV timer screen. The timer starts immediately.
ICV Time Interval	<b>Press and hold</b> the ICV icon to activate the time interval setting. Timing is adjustable from 20 seconds to 2 minutes, 30 seconds. The factory setting is 1 minute, which uses approximately 1 liter of fluid.
ICV Low Fluid Indicator	The ICV icon will display three orange colored dots (representing the intake ports) when the fluid is low (1 liter or less) or if the supply tank is empty. These dots are gray when the fluid level is above 1 liter. For details on the ICV panel control on the cabinet and refilling the supply tank, see “A-dec ICV Vacuum-Line Cleaner” on page 25.
 <b>NOTE</b>	If your configuration does not include an ICV option, the ICV icon will not appear on your control center touchscreen.

## How to Run Chair Functions

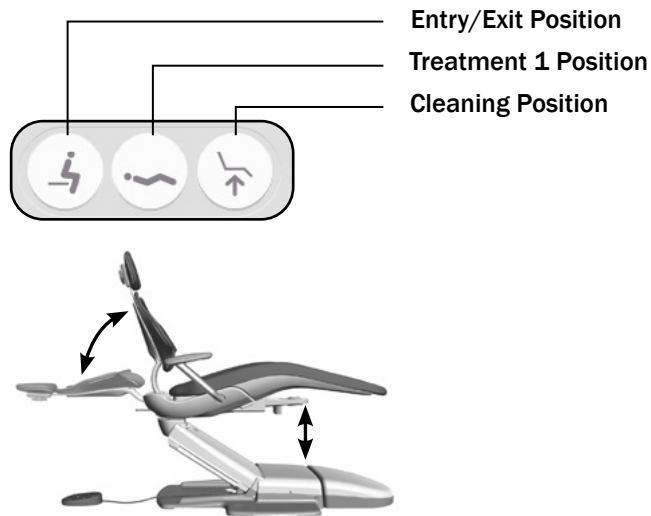

Function	Actions
<b>Entry/Exit Position</b>	Moves the chair to the corresponding preset position set on the dental chair. The factory default is an inclined “entry/exit” position, which can only be changed via the chair footswitch or system touchpad.
<b>Treatment 1 Position</b>	Moves the chair to the corresponding preset position set on the dental chair. The factory default is a supine “treatment” position, which can only be changed via the chair footswitch or system touchpad.
<b>Cleaning Position</b>	Moves the chair back and base to the highest position for easier cleaning around the chair.



**NOTE** The control center will only display chair functions when an A-dec chair is connected through the data communication system (DCS). See your authorized A-dec dealer for more details about your specific configuration.

## How to Set Screen Functions

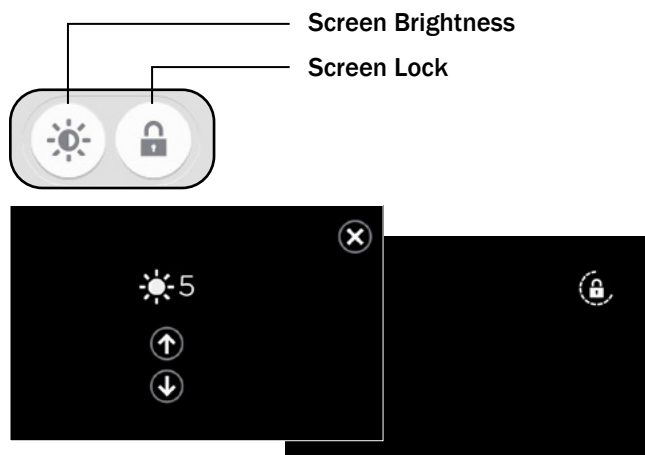

Function	Steps
<b>Screen Brightness</b>	<b>Press and hold</b> to activate the settings window. Press the arrows to change the brightness.
<b>Screen Lock</b>	<b>Press</b> and hold to activate the lock-out screen. A black screen with a countdown icon appears for 16 seconds, so you can clean, disinfect, or barrier protect the screen without unintentionally activating any commands.

## Clock/Timer (391 only)

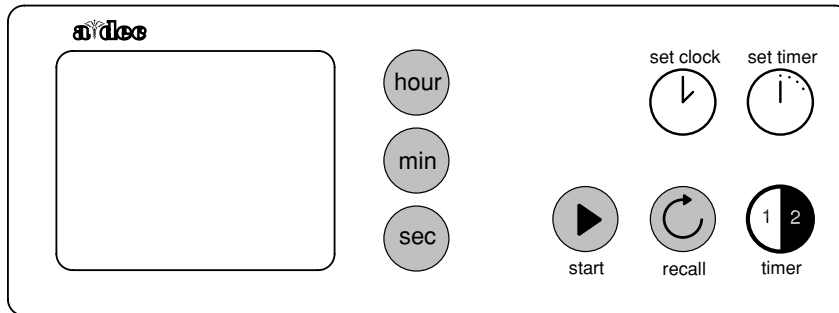

Function	Press and Hold...
Set the time.	Set clock and hour, min, or sec.
Set 12- or 24-hour display formats.	Set timer and set clock; AM/PM will only be displayed for the 12-hour format.
Set the countdown timer.	Set timer and min or sec until the desired time is reached.
Start the timer.	Start/stop
Stop the timer.	Start/stop
Clear the timer.	Stop the timer then press and hold set timer for three seconds.
Recall last start time.	Recall while timer is stopped.
Select timer 1 or 2.	Timer 1/2

### Countdown Timer

When the countdown timer reaches ten and five seconds, the alarm will be beep once; when it reaches zero, the alarm will beep three times. The timer will continue to count down until start/stop is pressed or until the timer reaches -60 seconds.

### Low-Battery Indicator

When the low battery indicator light begins to flash, replace the 9 volt alkaline battery. If the battery is removed and replaced within 14 seconds, the clock will not require resetting. The battery connector is polarized, so the battery will easily snap into place if it is in the correct orientation.



**CAUTION** Do not force the battery into place. If the battery doesn't snap to the connectors easily, reverse the orientation of the battery and reinsert it. Do not change the battery while the audible alarm is active.

## Operate the Task Light Switch

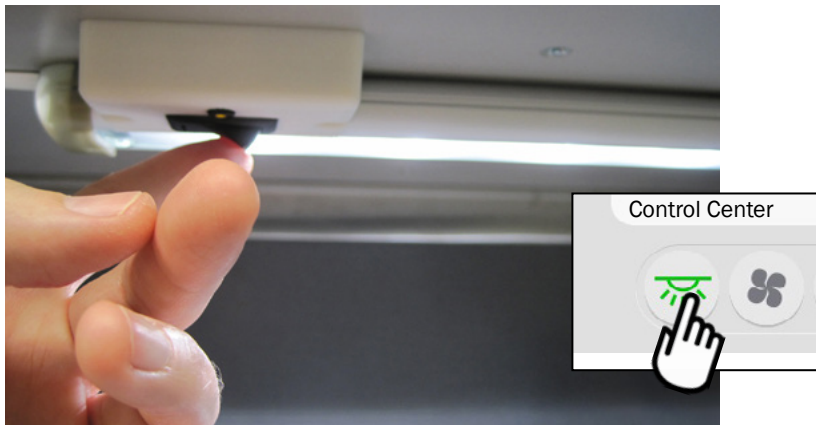

Some cabinets feature task lights with localized switches, while others include a rocker switch in a three-way lighting circuit. With this feature, you can turn the operatory task lights on or off from any cabinet in the circuit. This works the same way when combined with the control center touchscreen. You can turn all task lights on or off via the touchscreen or the rocker switch.

## Adjust the Monitor Mount Tension



The monitor should move smoothly and hold position when released. If your monitor drifts down or is too difficult to raise and lower, adjust the monitor mount vertical tension.

1. Remove the left-side upper arm cover. Pull from the front-left corner of the cover.
2. Use a standard screwdriver to turn the adjustment screw clockwise to increase tension or counterclockwise to decrease tension.
3. Lower the monitor down, then reinstall the cover.



## Remove Drawers/Shelves



### Storage Drawer

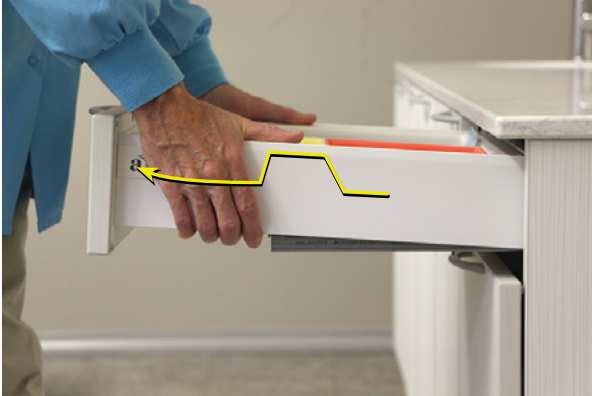

A-dec Inspire drawers and shelves remove for easy access to wiring and utilities, or to retrieve anything that may have fallen behind the drawers. To accommodate a variety of applications, A-dec Inspire includes several different drawer styles, each constructed with slightly different hardware.

Drawer/Shelf Style	Removal Method
Storage Drawer	Pull out, lift up, then pull out and down.
Swing-Out Shelf	Pull the left tab up and push right tab down.
Equipment Drawer	Press in the orange tabs and lift out.

### Swing-Out Shelf



### Equipment Drawer

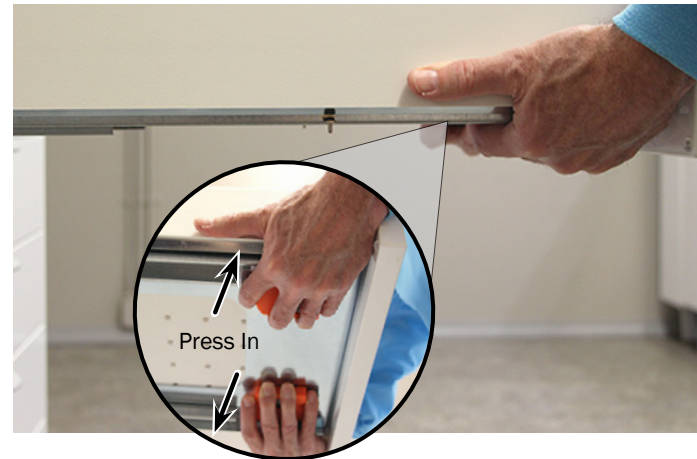

## Adjust Storage Drawer Face Alignment



**CAUTION** To avoid damaging the screws, use a #2 Pozidriv® screwdriver to adjust the screws that move the drawer face.

Storage drawers include adjustment screws on both sides of the drawer to correct drawer face alignment. To access the screws, remove the A-dec cover. The screw furthest from the drawer face adjusts up and down alignment. The screw closest to the drawer face adjusts side-to-side alignment.

### Up and Down Alignment

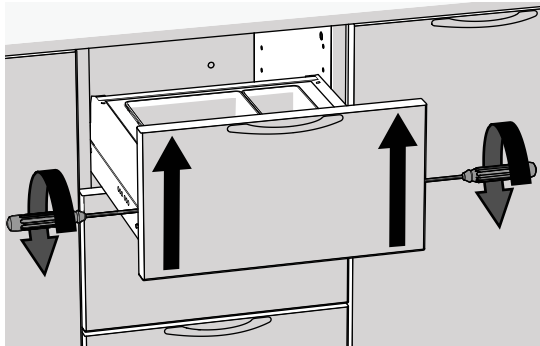

Each side can be adjusted independently.

### For up-and-down alignment:

1. Remove the A-dec cover.
2. On the left side, turn the screw counterclockwise to raise the drawer face or clockwise to lower the drawer face.
3. On the right side, turn the screw clockwise to raise the drawer face or counterclockwise to lower the drawer face.

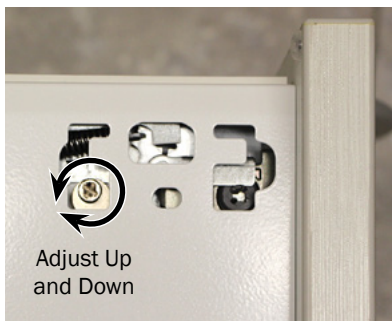

Left Side of Drawer

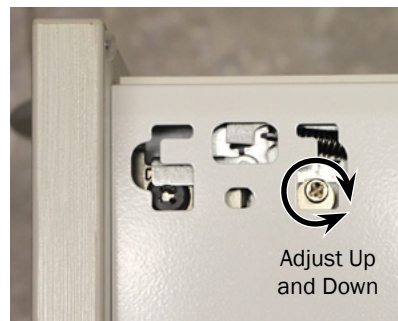

Right Side of Drawer

## Adjust Storage Drawer Face Alignment *(continued)*

### Side-to-Side Alignment

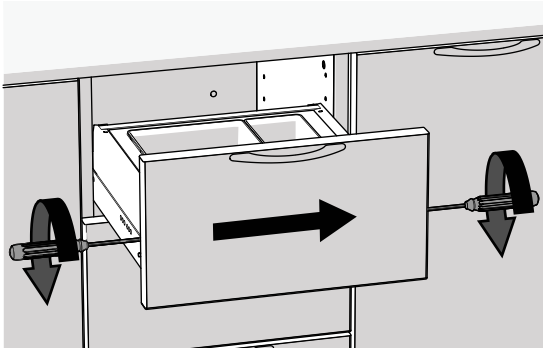

Adjust both sides  
at the same time.



Left Side of Drawer



Right Side of Drawer



**CAUTION** To avoid damaging the screws, use a #2 Pozidriv® screwdriver to adjust the screws that move the drawer face.

### For side-to-side alignment:

1. Remove the A-dec cover.
2. On the left side, turn the screw counterclockwise to move the drawer face right or clockwise to move the drawer face left.
3. On the right side, turn the screw the same number of increments, but clockwise to move the drawer face right or counterclockwise to move the drawer face left.



**NOTE** Make sure to turn the left- and right-hand screws in equal increments. To simplify the adjustment, adjust both sides at the same time.

## Adjust Equipment Drawers

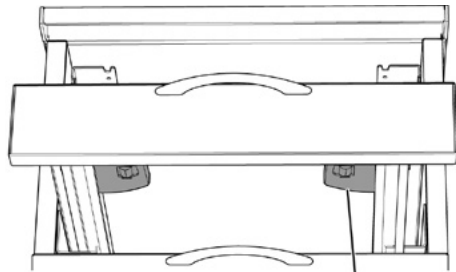

To adjust the drawer face position on equipment drawers, use the built-in adjustment mechanism located under the drawer.

1. **Side-to-Side Adjustment:** Rotate all barrels in the direction you want the drawer face to move.
2. **Up-and-Down Adjustment:** Slide the gray tab on the side to be moved. Slide the tab toward the back of the drawer to raise the drawer face.

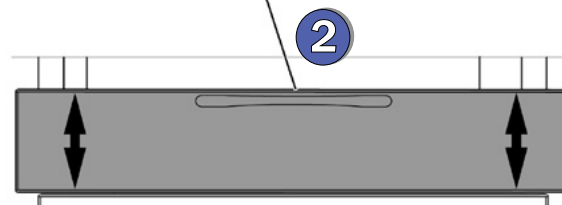
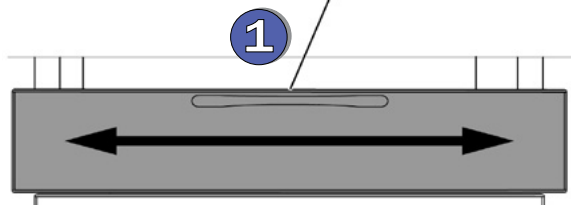
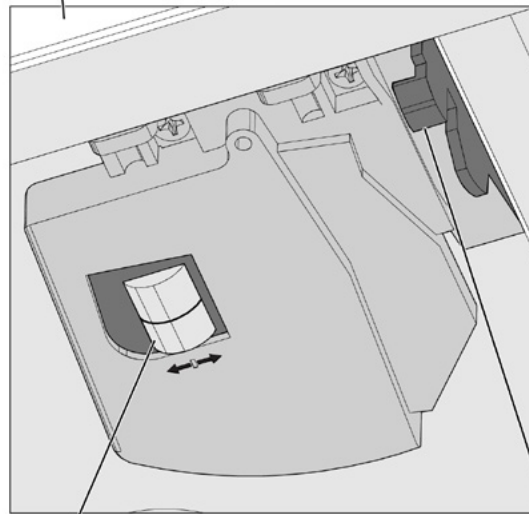

## Adjust the Tray Holder Mount Rotation Tension (396 cart only)

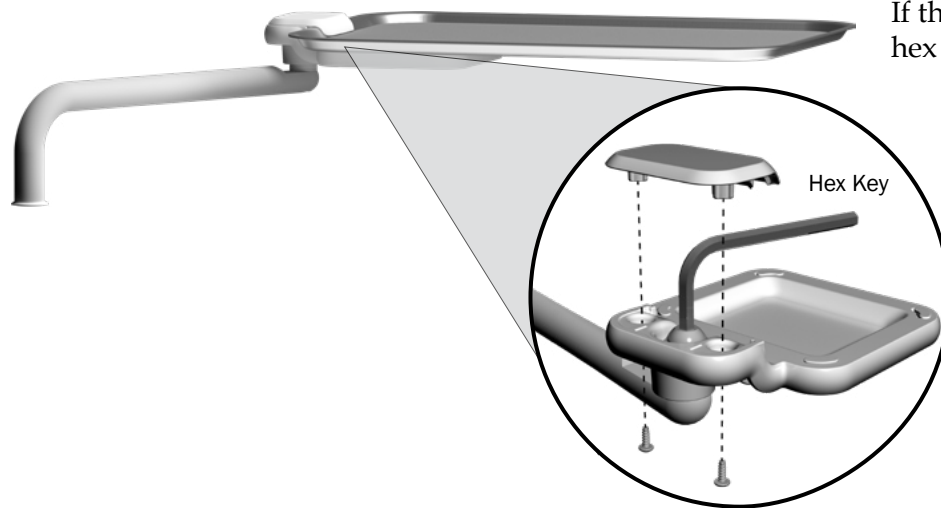

If the tray holder mount rotation is too tight or too loose, use a 7/32" hex key to adjust the tension:

1. Use a Phillips head screwdriver to remove the cap screws, then remove the cap.
2. Insert the hex key into the tension bolt and turn clockwise to increase the tension.
3. Replace the cap and secure with the screws.

## Adjust Swing-Out Shelf Tension

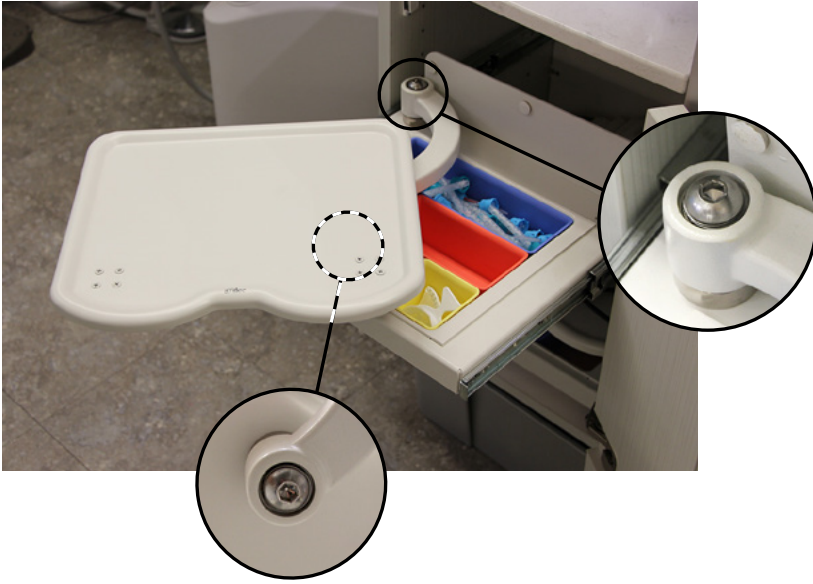

Swing-out shelves include two simple tension adjustment points – one on each side of the shelf arm (one above and one below the shelf). Use a 5/16" hex key to adjust the tension.

## Rearrange Drawers



All drawer banks are pre-drilled so the drawers can be rearranged after installation if required. Simply remove the drawer slides and reinstall them at selected levels to arrange the drawers in the desired order.



## Remove and Replace Doors

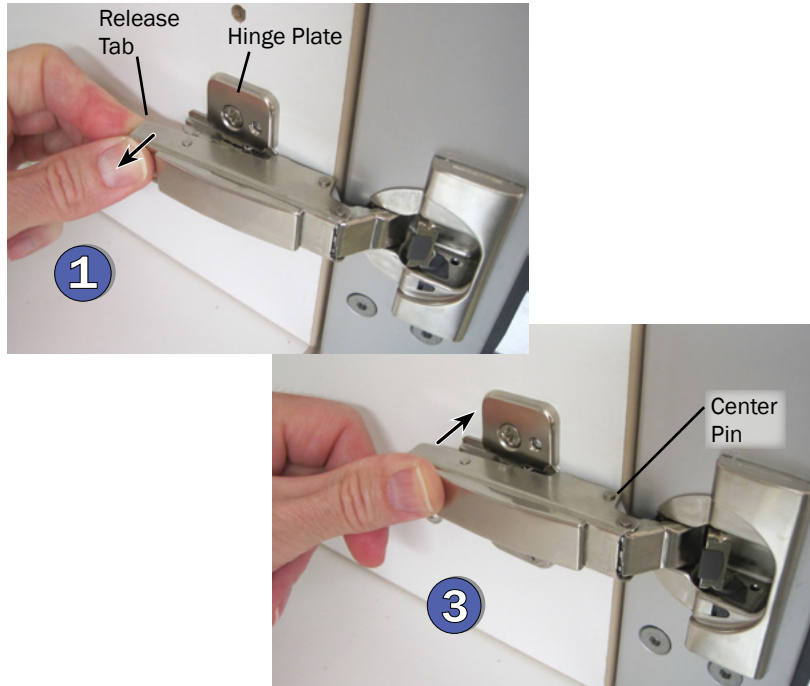

**WARNING** Do not attempt to remove the bifold doors on a 592 central console or 595 X-ray insert. The doors are heavy and can cause injury if not properly supported when they are removed.

Door hinges include a quick-release tab for easy removal. Start with the lower hinge and hold on to the door during this procedure:

1. Pull the quick release tab on the end of the hinge.
2. Repeat for the upper hinge and carefully remove the door.

To reinstall the doors, start with the upper hinge:

3. Align the center pin with the front of the hinge plate and snap the hinge in place.
4. Swing the door several times to ensure that the hinge is secure.

## Deactivate Door Soft-Close Feature

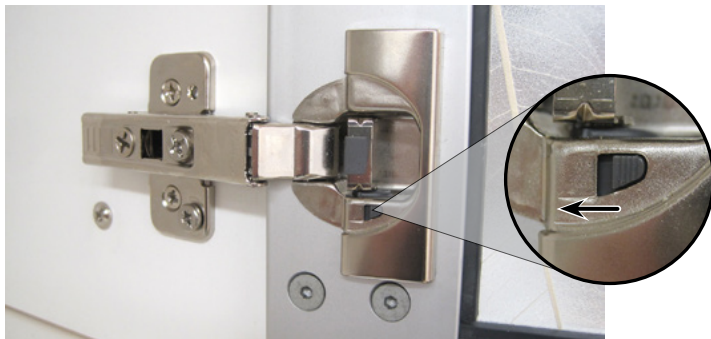

You can deactivate the soft-close feature, if desired. To deactivate, slide the black switch toward the cabinet on all hinges for that door.

## Adjust Hinges/Door Alignment



**CAUTION** To avoid damaging the screws, use a #2 Pozidriv® screwdriver to adjust the door hinge screws.

To adjust the door alignment, follow the guidelines below.

Side to Side

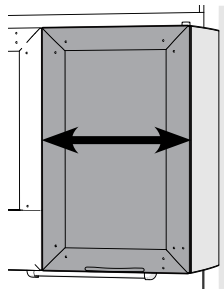

Back to Front

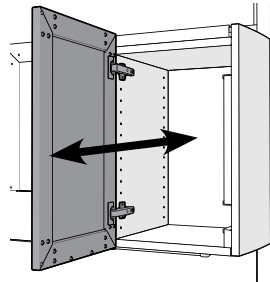

Up and Down

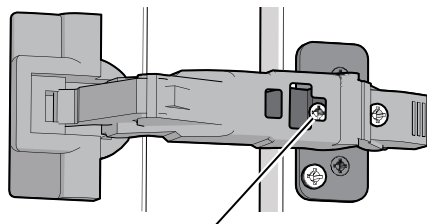
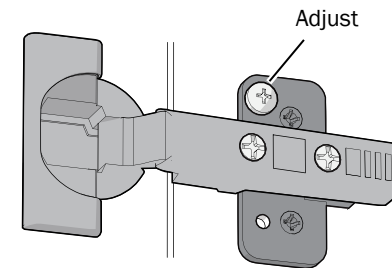
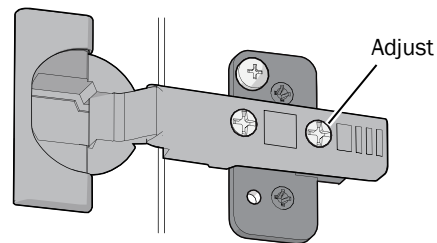
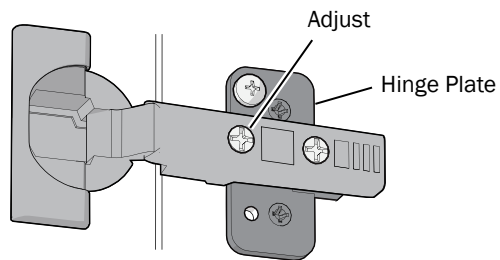
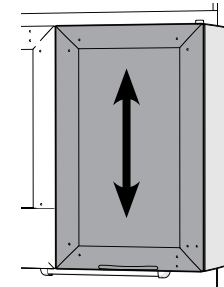

For 155 degree hinges, close the door slightly for better access to the screw.



**NOTE** The screw on the hinge plate may be at the top or bottom, depending on the door configuration.

## Move the Cart (396 cart only)



**CAUTION** Take care when maneuvering the cart over floor obstacles. A-dec carts are not intended to roll over thresholds or other floor obstacles. Secure the cart drawers and lift the cart high enough for the casters to move over any floor obstacles.

Use two hands on top of the cart at all times when moving it, and ensure that the front is facing in the direction it's moved.

## Cup, Glove, Mask, and Towel Dispensers



To ensure that a glove or mask carton is secure in the dispenser, twist the elastic band at least once before looping the end over the box and around the dispenser tab.

Order dispenser refills that meet the following specifications:

Product	Dispenser Specification
Cups	5 oz; No. PO-5 or equivalent
Glove	9-1/2"L x 5"W x 3"H carton
Masks	7-1/2"L x 3-3/4"W carton
Paper Towels	9-1/2" x 9-1/4" Z- or Multi-Fold

## Soap and Hand Sanitizer Dispensers

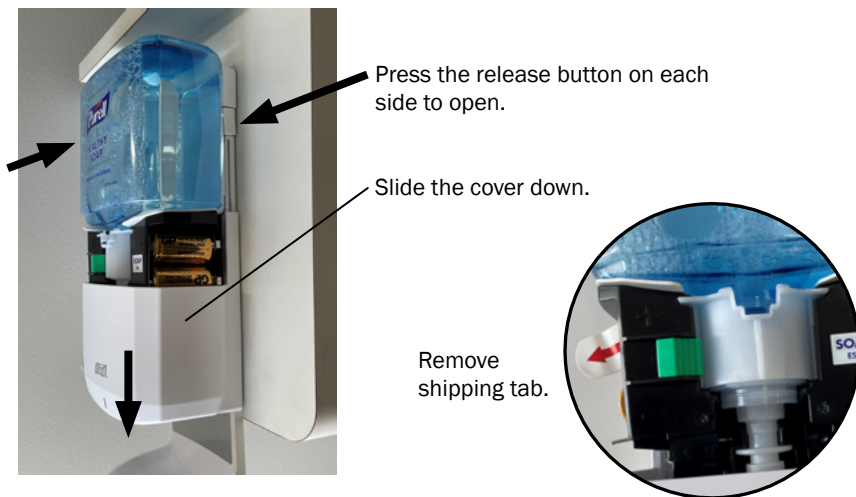

If the auto soap and hand sanitizer dispensers are full, but not working, open the units and ensure that the shipping tabs were removed.

For refills, order the following:

Product	Part Number/Description
Purell® Soap Refill	90.1861.00 2 Pack Refill Kit
Purell® Hand Sanitizer Refill	90.1860.00 2 Pack Refill Kit

### Replace the Batteries:

If the indicator light is not flashing and there is soap in the dispenser (and the shipping tab has been removed), replace the batteries.

1. Press the dispenser release buttons and slide the cover down.
2. Insert two new size C alkaline batteries.



**NOTE** Do not mix old and new batteries.

## Barriers Drawer



Use the barrier drawer for convenient access to common single-use items such as:

- instrument sleeves
- chair covers
- barrier rolls
- paper tray covers.

Use the straps to secure the instrument sleeve boxes. The small plastic roll is for 4" barrier film. The large spool is for chair covers. To install a new roll of covers:

1. Remove the spool from the keyhole.
2. Insert the roll of chair covers onto the spool before replacing it.
3. Feed the chair covers through the black grommet on the top shelf.

## Foot-Activated Faucet



For sink modules that include a foot-activated faucet, water temperature and flow are determined by the faucet handle position. To set, press the foot pedal and move the faucet handle until you reach your desired temperature and flow rate.



## Add Auxiliary Devices

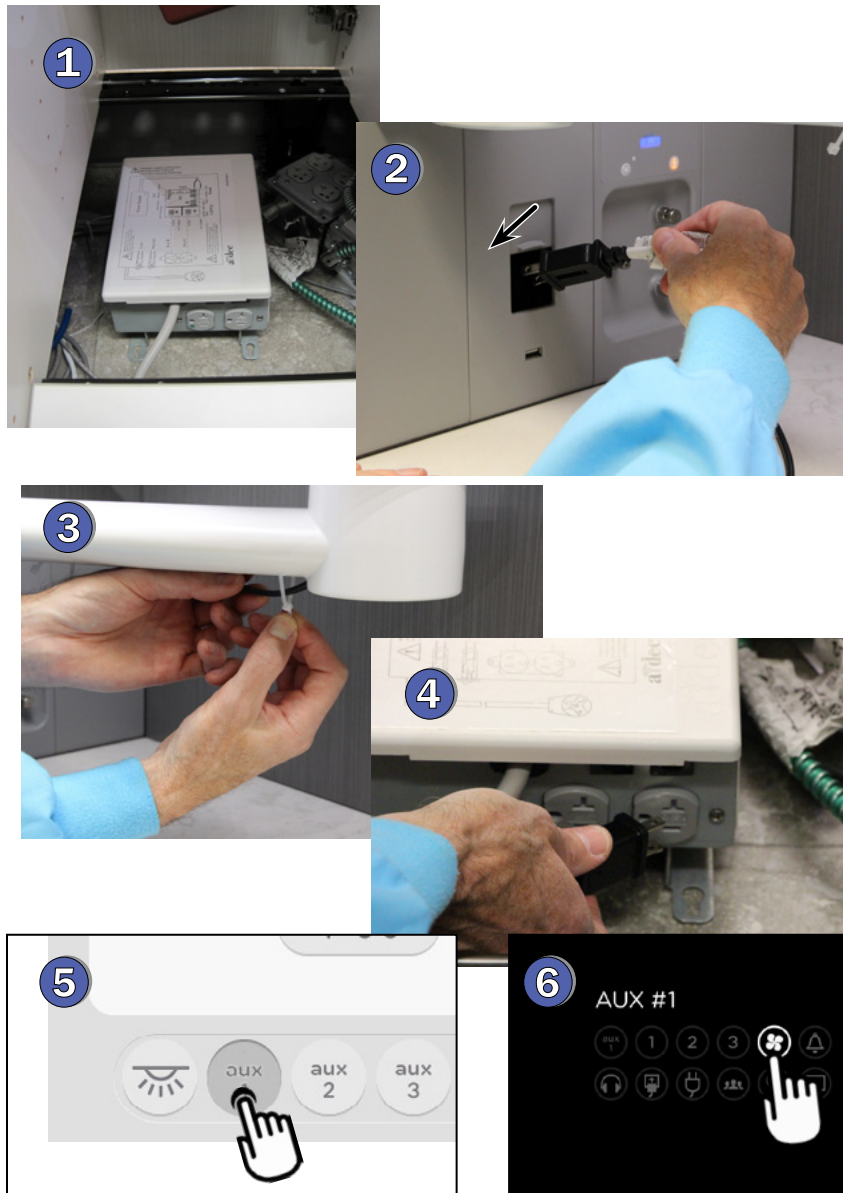

A-dec Inspire uses the same A-dec relay and data communication system (DCS) technology featured in A-dec chairs and delivery systems, so you can add auxiliary devices now or in the future.

If you have a 591 Treatment Console with a control center, follow these steps to integrate a device and control via the touchscreen:

1. Remove the cabinet false bottom panels to locate the distribution or quad box in the base of the cabinet.
2. Route the power cord through the power panel or countertop cord drop to the cabinet base.
3. Hide the cord with cable ties (e.g., for devices on a floating shelf).
4. Plug the device into the distribution box.
5. On the control center, press and hold an Aux position to change its icon.
6. Choose the appropriate icon for the device and press X to save the setting (also, see “How to Run and Set Auxiliary Devices” on page 8).



**NOTE** Up to three auxiliary positions/icons are available on the control center, but your configuration may vary and depends on how your equipment was installed. More than one device can be added to the same position/icon. Your A-dec delivery system deluxe touchpad may concurrently control two of the auxiliary positions and associated devices. For more details, contact your authorized A-dec dealer.



## A-dec ICV Vacuum-Line Cleaner

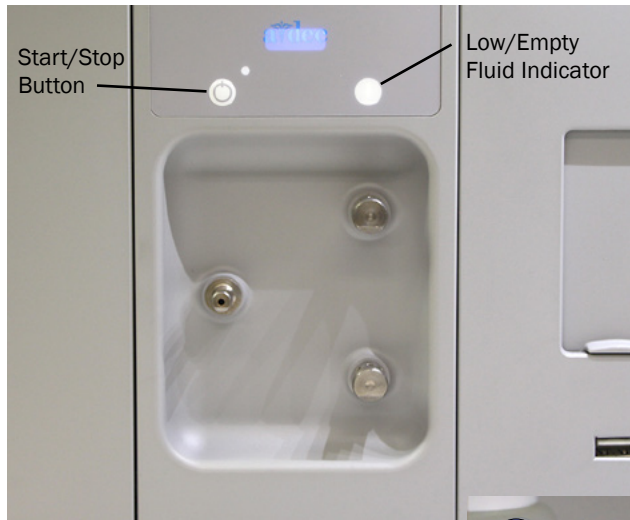

### Operate ICV

A-dec recommends that you clean your vacuum lines at the end of each day. ICV makes that a quick and easy process. To operate ICV:

1. Plug the HVE and saliva ejector into the ICV faceplate and open the valves.
2. Press the start/stop button on the faceplate or press the ICV icon on the control center (see “How to Run and Set the A-dec ICV Vacuum-Line Cleaner” on page 9).
3. When the cycle is complete, close the valves and return the instruments to their holders.



**NOTE** The factory default run time for ICV is 1 minute, which uses about 1 liter of fluid. See “How to Run and Set the A-dec ICV Vacuum-Line Cleaner” on page 9 to change the ICV run time on the control center.

### Fill the Tank

Fill the tank when the low fluid indicator illuminates. To fill the tank:

1. Disconnect the fluid tubing near the handle.
2. Disconnect the indicator tubing at the base of the tank.
3. Remove the cap, then add cleaner and water as per the manufacturer’s recommendations.

# Clean/Maintain

## Barrier Protection

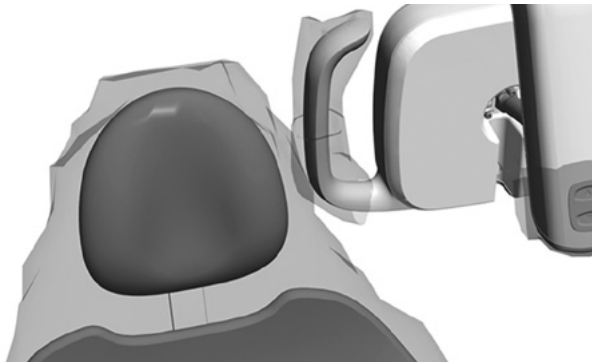

**NOTE** For proper use and disposal of barriers, see the barrier manufacturer's Instructions for Use.

A-dec recommends barrier protection for all applicable touch and transfer surfaces. Touch surfaces are areas that come into contact with hands and become potential cross-contamination points during dental procedures. Transfer surfaces are areas that come into contact with instruments and other inanimate objects.

In the USA, barriers must be produced under the Current Good Manufacturing Practice (CGMP) as specified by the U.S. Food and Drug Administration (USFDA). For regions outside the USA, refer to the medical device regulations specific to your location.



**IMPORTANT** For recommendations on cleaning and chemical disinfection of touch and transfer surfaces (where barrier protection is not applicable or when barriers are compromised), please see the *A-dec Equipment Asepsis Guide* (p/n 85.0696.00).



## Control Center Protection

Use standard 4" x 6" barrier film (blue or clear) on the control center screen to support asepsis protocols. Standard touchscreen wipes or cleaner may be used to clean the screen. Use a disinfectant wipe when the barrier is compromised. Be sure to prevent liquid from dripping into the seam and housing. Do not use any cleaners or disinfectants with a spray applicator on the control center.

## Surface Management



To preserve your investment, A-dec recommends that you use barriers where possible. Where barriers are not practical, or when cleaning and disinfection are required, use the least harmful EPA-registered disinfectants that can provide the protection you need, while reducing potential harm to the equipment.

No solution is 100 percent safe. But there are choices available today that offer a balance between effective disinfection and minimal impact to your equipment, office staff, and patients. For A-dec Inspire, use the following guidelines – and always follow the cleaner/disinfectant manufacturer's directions for use.

### Least Harmful:

- ▶ Barriers
- ▶ EPA-registered disinfecting wipes with:
  - quaternary ammonium chlorides (“quats”) with less than 25% isopropyl alcohol
- ▶ EPA-registered disinfecting sprays with:
  - high-dilution, water-based phenols
- ▶ Mild dishwashing liquid and water (for cleaning only)



### Most Harmful:

- ▶ Sodium hypochlorite (bleach)
- ▶ Hydrogen peroxide (pH <4)
- ▶ Isopropyl alcohol (>40%)
- ▶ Products with abrasives (e.g., pumice, calcium carbonate)
- ▶ Abrasive applicators/scrubbers





**NOTE** In general, disinfecting wipes (when properly used) are less harmful than disinfecting sprays – primarily due to overspray and lack of consistent application. Always follow the disinfectant manufacturer's directions for use.

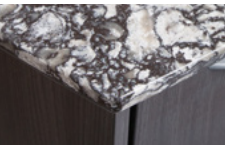
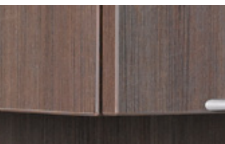

**IMPORTANT** For a quick reminder of these guidelines, see the *A-dec Inspire Asepsis Quick Reference* (p/n 86.0632.00), which was included with your dental furniture order. For more details on cleaning and disinfecting, see the *A-dec Equipment Asepsis Guide* (p/n 85.0696.00), which is available in the Resource Center at [www.a-dec.com](http://www.a-dec.com).

## Surface Management *(continued)*

Surface/Item	Routine Cleaning	Light Stains	Heavy Stains/Scratches/Burns	Do NOT Use
<b>Solid Surface</b> 	Soft cotton cloth with a solution of mild dishwashing liquid and warm water.	Soap and water, glass cleaner, or non-abrasive household cleaners such as Fantastik® and Formula 409®.	Matte finishes only: Apply an abrasive cleaner (such as Comet®, Soft Scrub®, Bon Ami®, etc.), then buff with a purple Scotch-Brite® pad using a circular motion.	Aggressive or oxidizing chemicals. See page 27 for other harmful disinfectants.
<b>Quartz</b> 	Soft cotton cloth with a solution of mild dishwashing liquid and warm water.	Soap and water, glass cleaner, or non-abrasive household cleaners such as Fantastik and Formula 409®.	Contact A-dec customer service.	Aggressive or oxidizing chemicals, abrasive, strong alkaline, or highly acidic cleaners (such as bleach, Comet®, Soft Scrub®, SOS®, products with pumice, paint removers, furniture strippers, and tarnish, silver, or oven cleaners). See page 27 for other harmful disinfectants.
<b>Laminate Surfaces</b> 	Soft cotton cloth with a solution of mild dishwashing liquid and warm water.	Soap and water, or non-abrasive household cleaner/detergent and a soft bristled brush.	Use a soft bristled brush with a paste of baking soda and water. Lightly scrub for 10-20 seconds.	Aggressive or oxidizing chemicals, bleaching agents, or cleaners containing lye, steel wool, or other abrasives. See page 27 for other harmful disinfectants.
<b>Infills</b> 	Soft cotton cloth with a solution of mild dishwashing liquid and warm water.	Soap and water, glass cleaner, or non-abrasive household cleaners such as Fantastik and Formula 409®.	Contact A-dec customer service.	Aggressive or oxidizing chemicals. See page 27 for other harmful disinfectants.

## Remove/Install Base Covers

### Side Corners

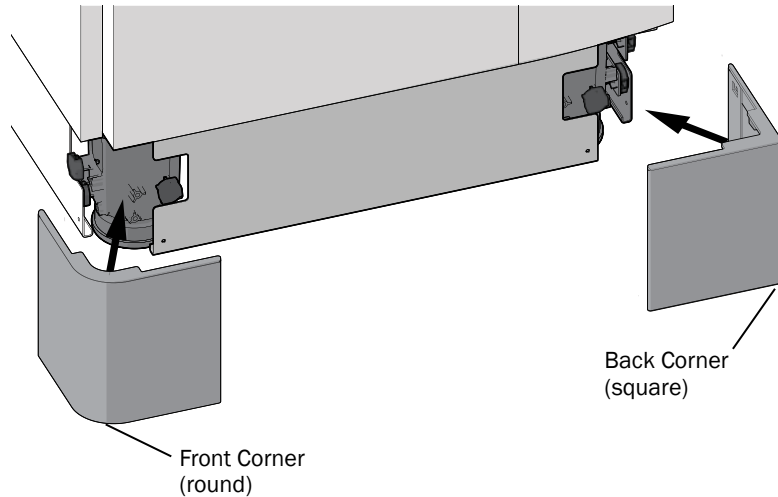

### Front/Back Straight Panels

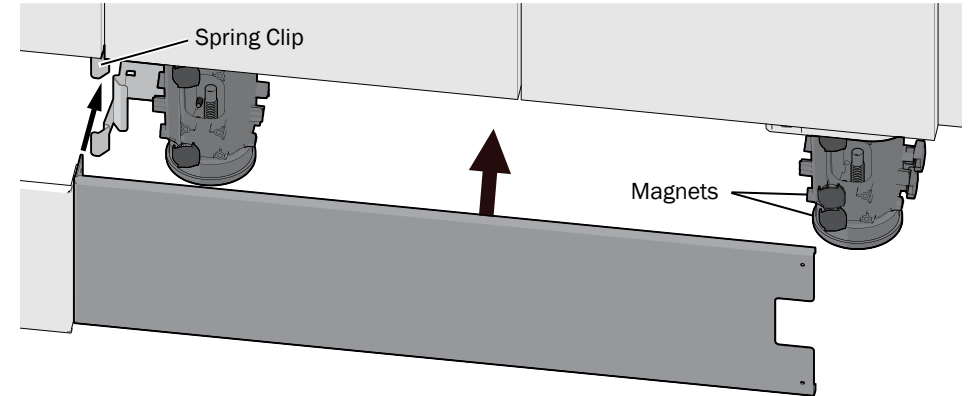

Cabinet base covers are easily removed for cleaning or to access utilities. Pull the covers straight out to remove them. When you reinstall the covers, make sure they attach in their original location onto magnets or inserted into spring clips. Place the rounded corner base covers on the front corners of the cabinet and the square covers on the back corners.



**NOTE** Some base covers may be shaped and located differently than those shown above, but are attached and held in the same manner.



**CAUTION** Base covers are held in place with high strength magnets. To avoid pinching fingers when removing or installing the base covers, hold the base cover by the edges.

## Common Replacement Items

Item/Description	Part Number
Interchangeable Drawer Bins  	57.0135.01 white 57.0134.01 blue 57.0133.01 red 57.0132.01 yellow
Purell® Soap Refill 	90.1861.00 pkg of 2
Purell® Hand Sanitizer Refill 	90.1860.00 pkg of 2

Contact your authorized A-dec dealer for available A-dec Inspire replacement items.



# Specifications

---

## Load Capacities

Floating Shelf:	10 lb (4.5 kg)
Cart:	50 lb (22.6 kg) total
<i>Top</i>	10 lb (4.5 kg)
<i>Drawers/Shelves</i>	10 lb (4.5 kg) each
<i>Tray Holder Mount</i>	5 lb (2.3 kg) each



**IMPORTANT** For electrical specifications, identification of symbols, and other regulatory requirements, see the *Regulatory Information, Specifications, and Warranty* document (p/n 86.0221.00) available in the Resource Center at [www.a-dec.com](http://www.a-dec.com).



For quick access to this document online, scan, tap, or click this QR code, which points to: [a-dec.com/regulatory-guide](http://a-dec.com/regulatory-guide).



**NOTE** Specifications are subject to change without notice. Requirements may vary depending on your location. For more information, contact your authorized A-dec dealer.

---



 **A-dec Headquarters**

2601 Crestview Drive  
Newberg, Oregon 97132  
United States  
Tel: 1.800.547.1883 within USA/CAN  
Tel: +1.503.538.7478 outside USA/CAN  
[www.a-dec.com](http://www.a-dec.com)

**A-dec Australia**

Unit 8, 5-9 Ricketty Street  
Mascot, NSW 2020  
Australia  
Tel: 1.800.225.010 within AUS  
Tel: +61.(0).2.8332.4000 outside AUS

**A-dec United Kingdom**

Austin House, 11 Liberty Way  
Nuneaton, Warwickshire CV11 6RZ  
England  
Tel: 0800.ADEC.UK (2332.85) within UK  
Tel: +44.(0).24.7635.0901 outside UK



86.0526.00 Rev H  
Date of Issue 2024-04-04  
Copyright 2024 A-dec, Inc.  
All rights reserved.

IFUnewcov5